

NP12-9 Ah 12V9 Ah

Specifications

Nominal Voltage		12V
Rated capacity (20 hour rate)		9.0Ah
Dimensions	Length	151±1.5mm(5.94inch)
	Width	65±1mm(2.56inch)
	Height	94±1mm(3.70inch)
	Total Height	100±1mm(3.94inch)
Approx. Weight		2.5kg(5.51lbs)±4%



Outer dimensions (mm)

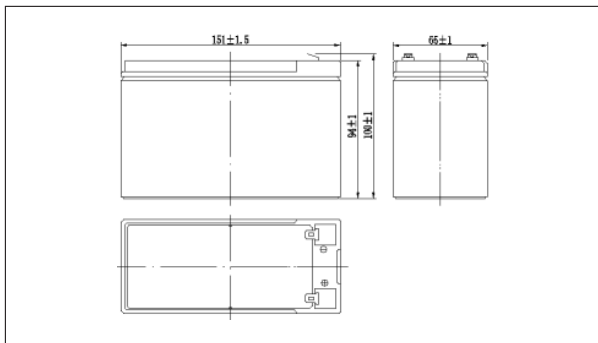

Terminal Type (mm)

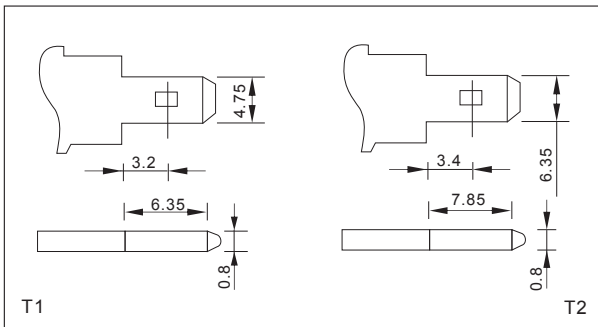

Characteristics

Capacity (25°C)	20HR(10.5V)	8.5Ah
	10HR(10.5V)	7.9Ah
	1HR(9.60V)	5.2Ah
Terminal type		T1/T2
Internal resistance (Fully charged, 25°C)		Approx. 20m Ω
Capacity affected by temperature (20HR)	40°C	102%
	25°C	100%
	0°C	85%
	-15°C	65%
Self-discharge (25°C)	3 months	Remaining Capacity:91%
	6 months	Remaining Capacity:82%
	12 months	Remaining Capacity:65%
Nominal operating temperature		25°C ±3°C(77°F ±5°F)
Operating temperature range	Discharge	-15°C~50°C(5°F~122°F)
	Charge	-10°C~50°C(14°F~122°F)
	Storage	-20°C~50°C(-4°F~122°F)
Float charging voltage(25°C)		13.50 to 13.80V Temperature compensation: -18mV/°C
Cyclic charging voltage(25°C)		14.50 to 15.00V Temperature compensation: -30mV/°C
Maximum charging current		2.55A
Maximum discharge current		127.5A(5 sec.)
Designed floating life(20°C)		5 years

Construction

Component	Positive plate	Negative plate	Container	Cover	Separator	Electrolyte	Safety valve	Terminal
Raw material	Lead dioxide	Lead	ABS	ABS	AGM	Sulfuric acid	Rubber	Copper

Constant Current Discharge Characteristics Unit:A(25°C,77°F)

F.V/Time	5min	10min	15min	30min	60min	2h	3h	4h	5h	10h	20h
9.60V	32.5	20.6	16.1	9.05	5.57	3.05	2.11	1.74	1.48	0.80	0.43
9.90V	31.5	20.0	15.7	8.87	5.48	3.03	2.09	1.73	1.47	0.80	0.43
10.2V	30.2	19.1	15.1	8.60	5.34	3.00	2.08	1.72	1.46	0.80	0.43
10.5V	28.9	18.3	14.6	8.39	5.24	2.96	2.07	1.71	1.45	0.79	0.43
10.8V	27.3	17.3	13.8	8.08	5.08	2.88	2.00	1.66	1.41	0.78	0.42

Constant Power Discharge Characteristics Unit:W(25°C,77°F)

F.V/Time	5min	10min	15min	30min	60min	2h	3h	4h	5h	10h	20h
9.60V	362	232	183	104	64.5	35.6	25.0	20.8	17.7	9.66	5.18
9.90V	351	225	179	102	63.5	35.4	24.9	20.6	17.6	9.62	5.16
10.2V	337	216	172	98.6	61.9	35.1	24.7	20.5	17.5	9.57	5.13
10.5V	323	207	166	96.2	60.7	34.6	24.5	20.3	17.4	9.52	5.10
10.8V	304	195	158	92.6	58.8	33.7	23.8	19.7	16.8	9.33	5.00

Note: The above characteristics data can be obtained within three charge or discharge cycles.

NP12-8.5Ah 12V8.5Ah

Discharge characteristics(25°C)

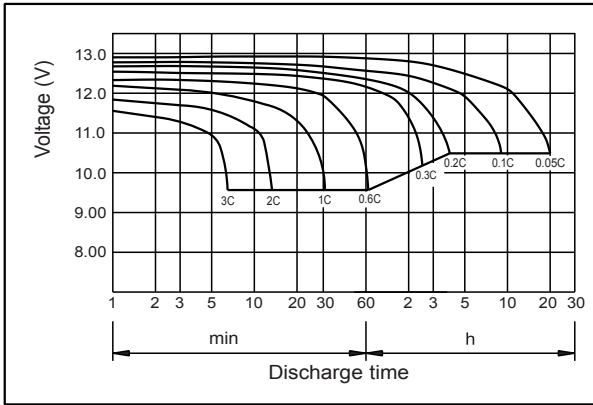

Charging characteristics (25°C)

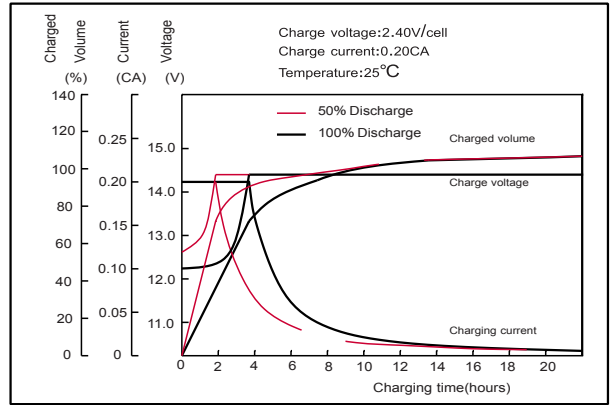

Effect of temperature on capacity

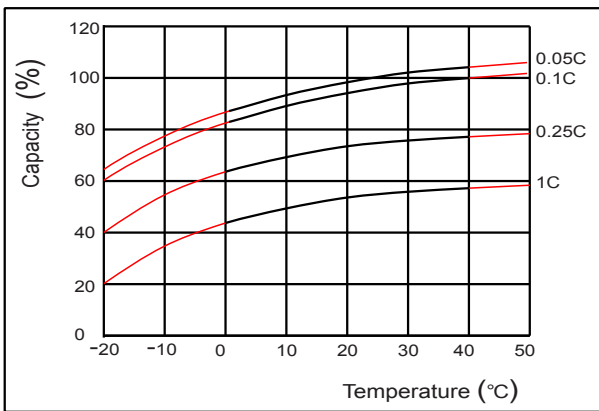

Self-discharge characteristics

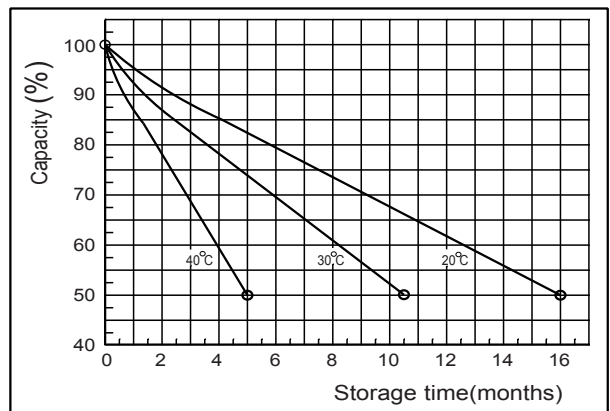

Floating life on temperature

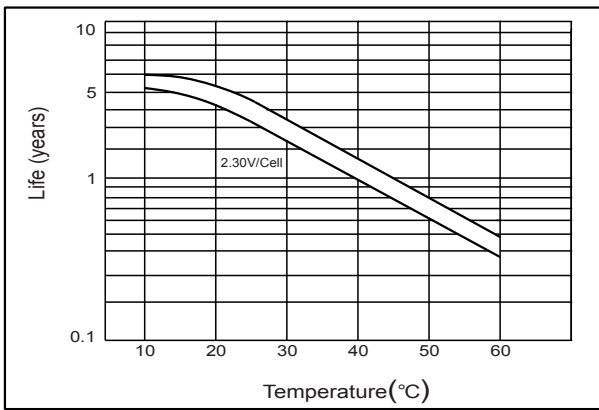

Cycle life on D.O.D.(25°C)

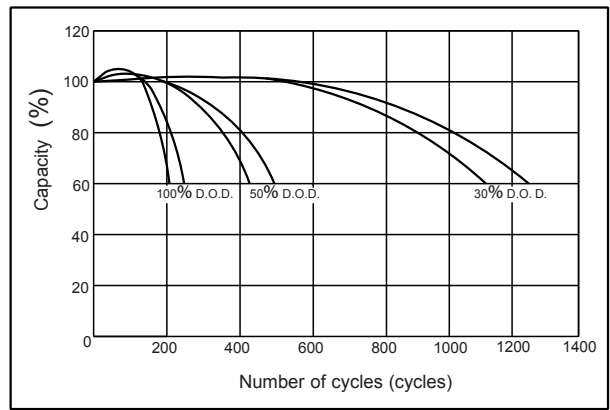

The relationship for OCV and Capacity (25°C)

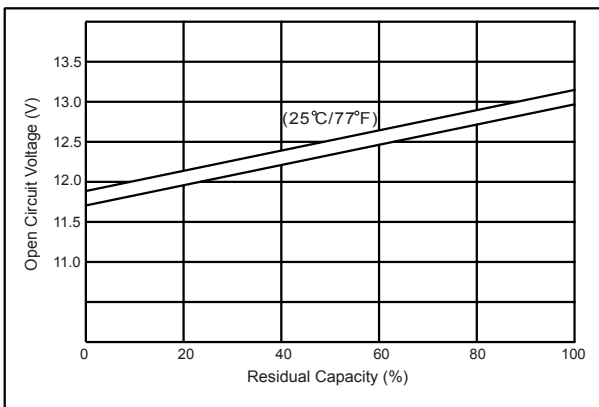

The relationship for Charging voltage and Temperature

